

Guide to Assembly & Usage

BiGDUG Cabinet Storage System - Base Cabinet

Information
If in doubt, contact the supplier

Read this guide thoroughly before commencing assembly and retain for future reference

Before commencing assembly, unpack carefully and check that all components ordered are included

Assembly should be undertaken by a minimum of two competent people

Tools – Spanner

Caution
During assembly, ensure to:

Take care during assembly and in use, particularly when lifting or stretching and when using tools

Wear appropriate clothing - protective gloves and footwear are recommended

Build on a suitable level floor, which is strong enough to support the load and allow adequate working space

Dispose of packaging materials responsibly

Warning
Rules for safe use of shelving:

Ensure these instructions are retained for reference and that users are aware of the rules for safe use

Never climb on the structure

Do not lean or support ladders, steps, or other objects

Always use safety steps to reach high items

Do not use in damp or wet conditions

Load heavy items on the lower shelves and lighter items on the higher shelves

This product is designed for hand loading only

Ensure that the maximum load carrying capacities are not exceeded

Please refer to the loading information supplied for details

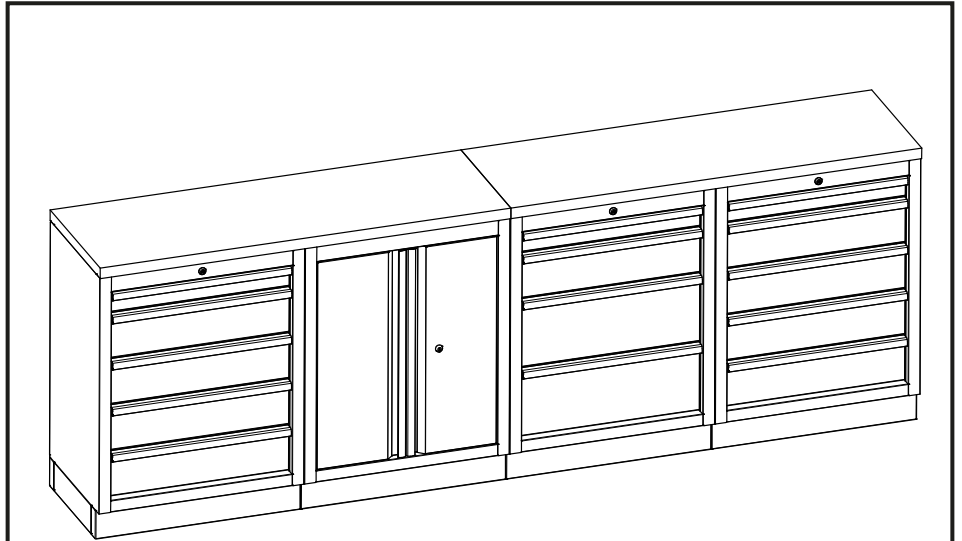

FIXINGS CHECK LIST

Component	Quantity
A M6 Bolt	6 Per Cabinet

If you have any missing components please take note of the part name and contact your supplier.

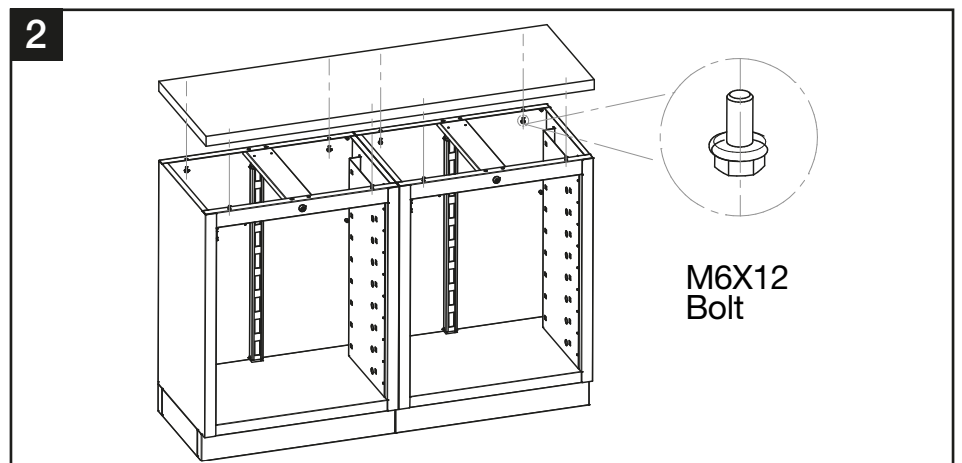
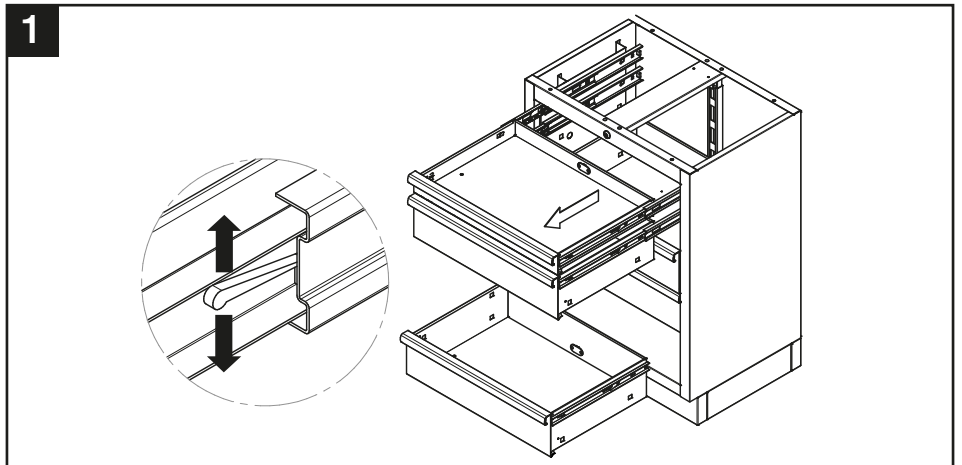

Guide to Assembly & Usage

BiGDUG Cabinet Storage System Perforated Tool Panel

Information
If in doubt, contact the supplier

Read this guide thoroughly before commencing assembly and retain for future reference

Before commencing assembly, unpack carefully and check that all components ordered are included

Assembly should be undertaken by a minimum of two competent people

Tools – Spanner

Caution
During assembly, ensure to:

Take care during assembly and in use, particularly when lifting or stretching and when using tools

Wear appropriate clothing - protective gloves and footwear are recommended

Build on a suitable level floor, which is strong enough to support the load and allow adequate working space

Dispose of packaging materials responsibly

Warning
Rules for safe use of shelving:

Ensure these instructions are retained for reference and that users are aware of the rules for safe use

Never climb on the structure

Do not lean or support ladders, steps, or other objects

Always use safety steps to reach high items

Do not use in damp or wet conditions

Load heavy items on the lower shelves and lighter items on the higher shelves



This product is designed for hand loading only

Ensure that the maximum load carrying capacities are not exceeded

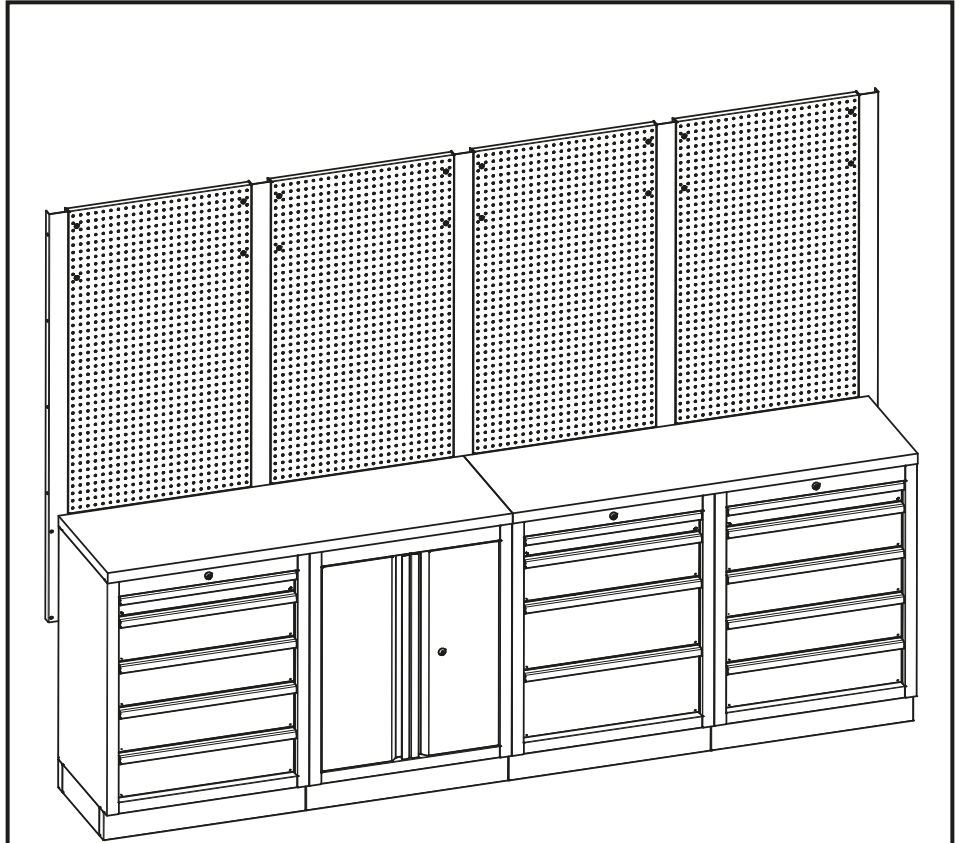
Please refer to the loading information supplied for details

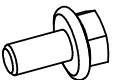

FIXINGS CHECK LIST

Component	Quantity
A M6 Bolt 	12
B M6 Nut 	12

If you have any missing components please take note of the part name and contact your supplier.

BiGDUG Cabinet Storage System - Perforated Tool Panel

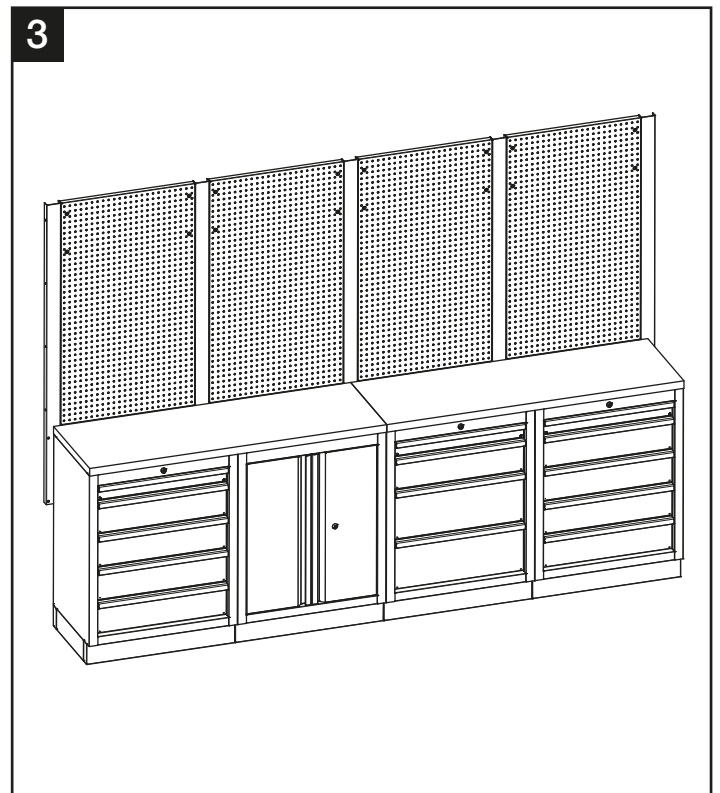
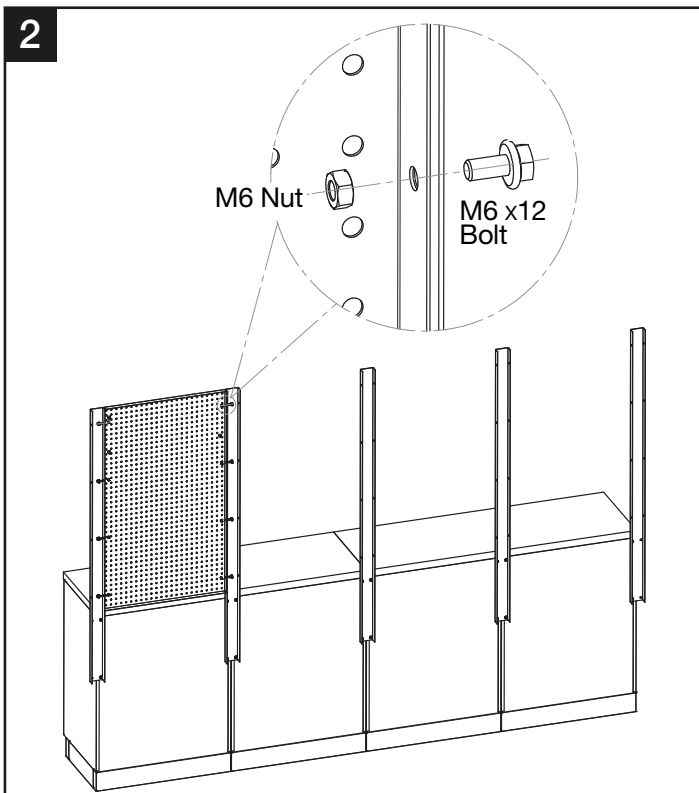
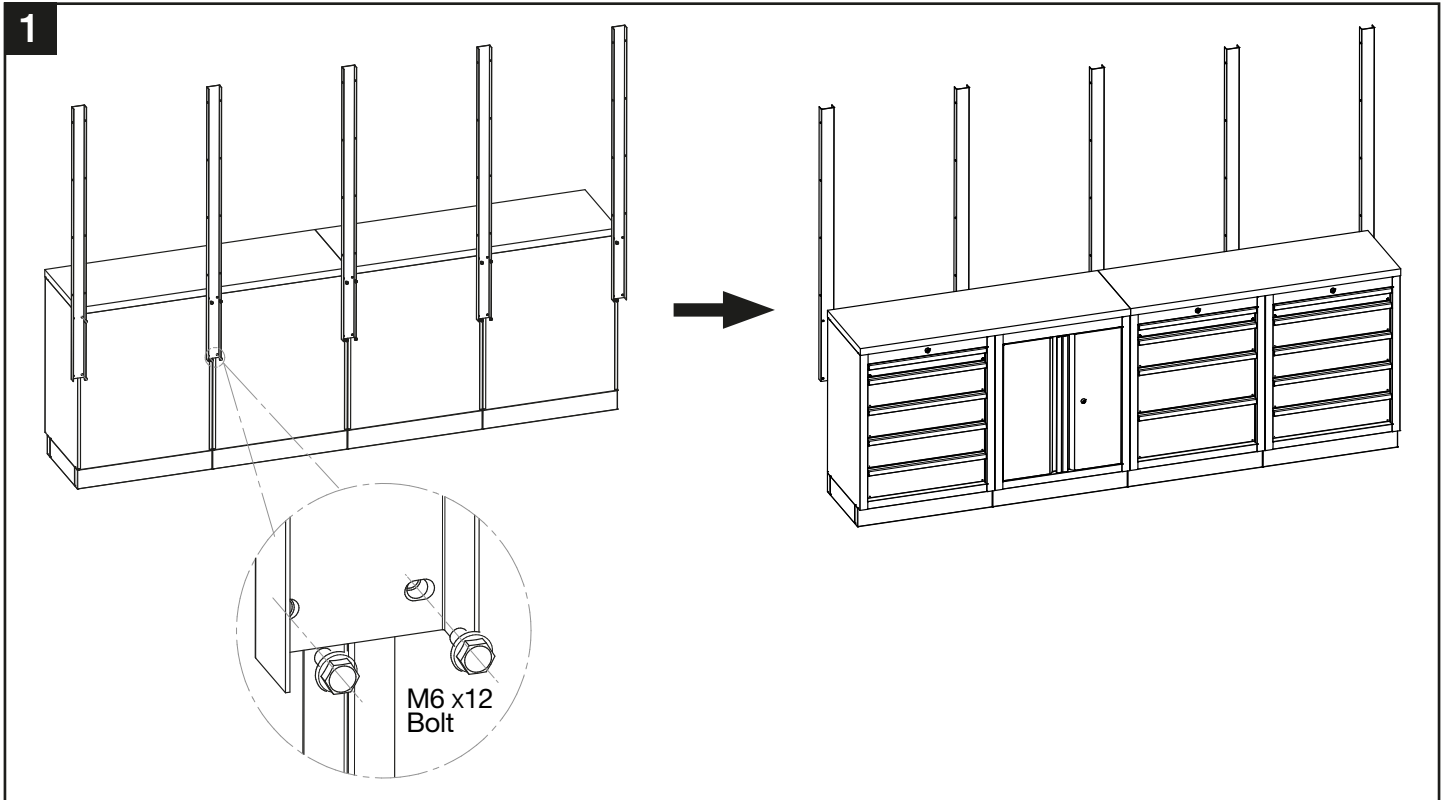



Guide to Assembly & Usage

BiGDUG Cabinet Storage System - Wall Cabinet

i Information
If in doubt, contact the supplier

 Read this guide thoroughly before commencing assembly and retain for future reference

 Before commencing assembly, unpack carefully and check that all components ordered are included

 Assembly should be undertaken by a minimum of two competent people

 Tools – Spanner

! Caution
During assembly, ensure to:

 Take care during assembly and in use, particularly when lifting or stretching and when using tools

 Wear appropriate clothing - protective gloves and footwear are recommended

 Build on a suitable level floor, which is strong enough to support the load and allow adequate working space

 Dispose of packaging materials responsibly

! Warning
Rules for safe use of shelving:

 Ensure these instructions are retained for reference and that users are aware of the rules for safe use

 Never climb on the structure

 Do not lean or support ladders, steps, or other objects

 Always use safety steps to reach high items

 Do not use in damp or wet conditions

 Load heavy items on the lower shelves and lighter items on the higher shelves



 This product is designed for hand loading only

 Ensure that the maximum load carrying capacities are not exceeded

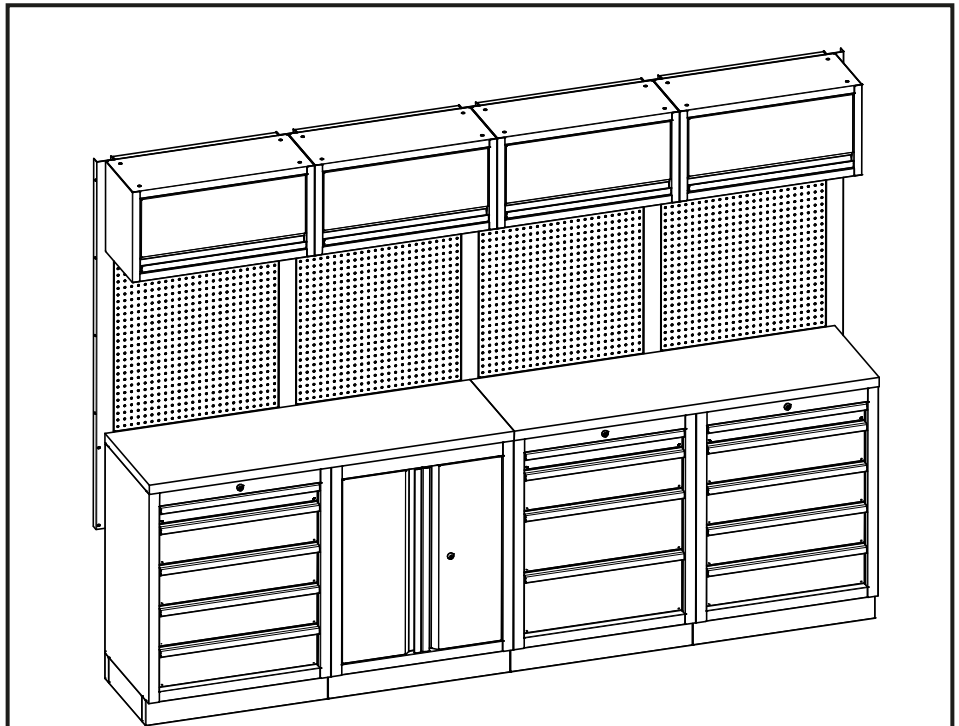
 Please refer to the loading information supplied for details



FIXINGS CHECK LIST

Component		Quantity
A M8 Bolt		4 Per Cabinet
B M8 Spring Washer		4 Per Cabinet
C M8 Washer		4 Per Cabinet

If you have any missing components please take note of the part name and contact your supplier.

