

3 Ton

FOLDING AXLE STAND

RWFAS3

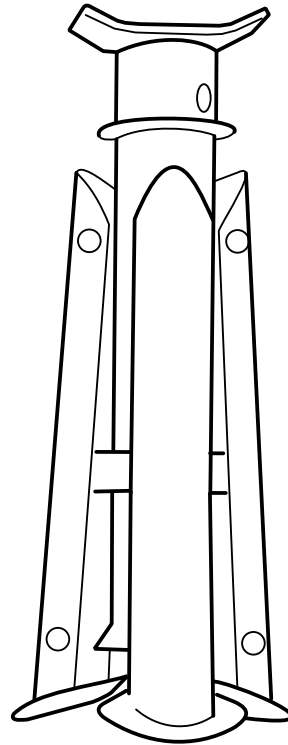
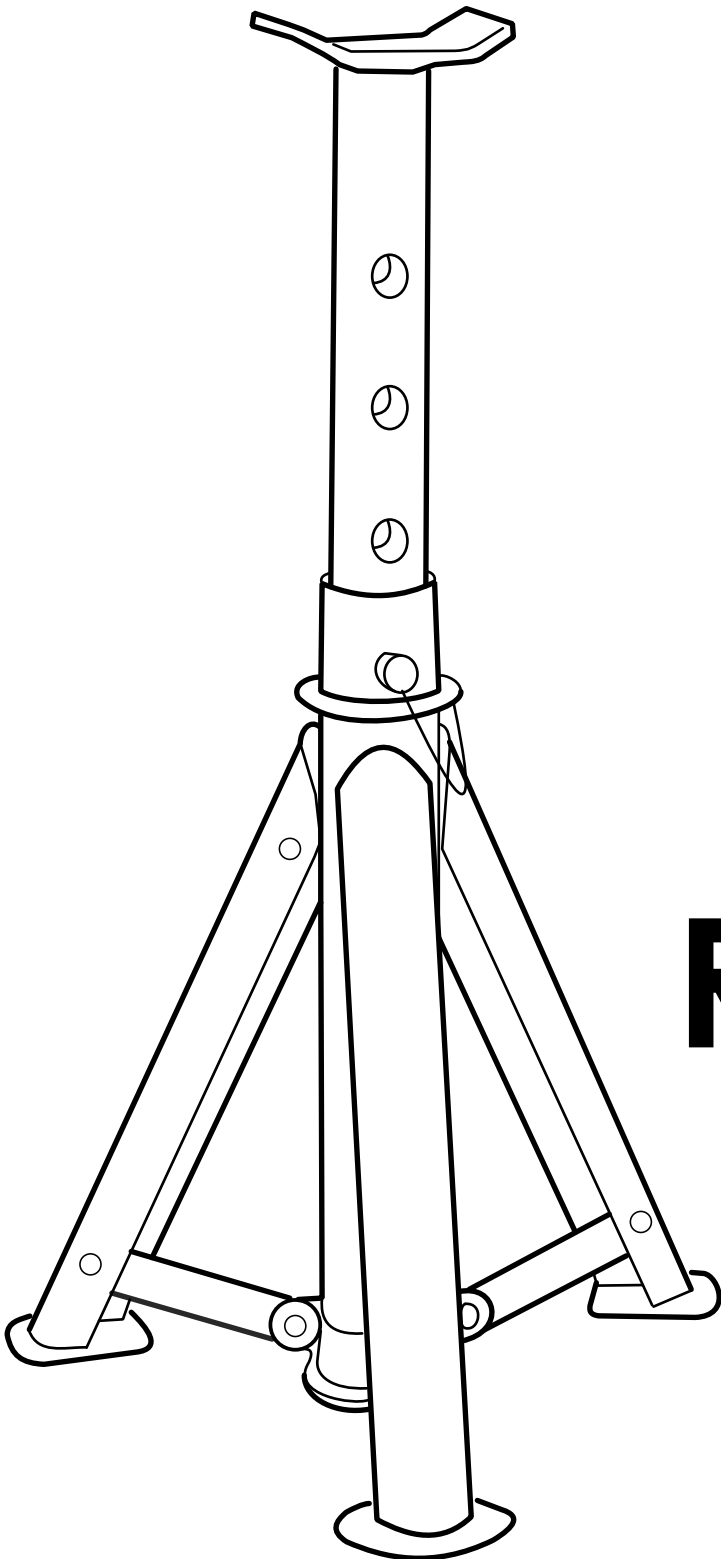

Rocwood



INSTRUCTION MANUAL

PLEASE READ & RETAIN

SAFETY WARNINGS - ALWAYS READ BEFORE USE

- Read these instructions carefully before use.
- Do not exceed the axle stands maximum load (1.5 ton each/ 3 ton per pair), The vehicle weight will be in the owners manual.
- Use only as specified in this manual.
- NEVER let children play in or around a vehicle that is on axle stands.
- ALWAYS make sure that before you work below the vehicle, a responsible person is aware in case of injury or accident.
- Do not use more than one pair of axle stands.
- Replace the warning label if it becomes unreadable.
- Use only on a hard, flat surface for example concrete.
- Make sure that you chock all the wheels that remain on the ground.
- Make sure that the supported vehicle cannot move.
- Set each axle stand below an appropriate point on the vehicle - See your vehicle owners manual for advice.
- Take care when using the axle stands on a three-wheeled vehicle or trailer.
- Upper and lower columns are to be used as a pair as supplied.
- Use stands as a matched pair to support one end of a vehicle only.
- For your safety, do not modify these axle stands

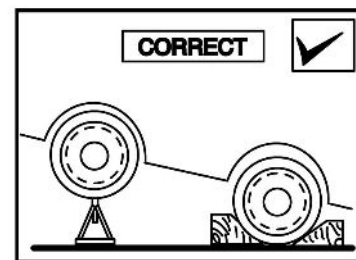
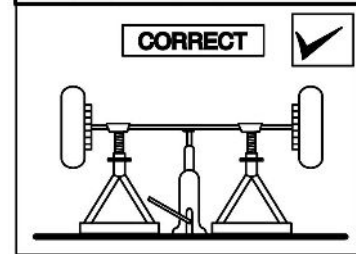
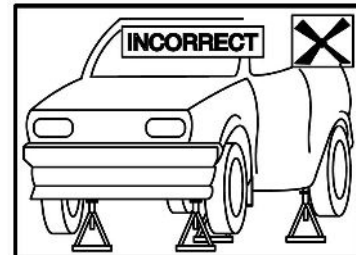
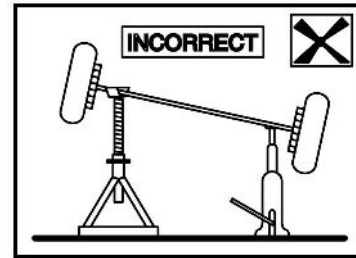

WARNING: USE ONLY ON A HARD, FLAT SURFACE FOR EXAMPLE CONCRETE.

WARNING: NEVER WORK UNDER A VEHICLE SUPPORTED ONLY BY A JACK.

WARNING: AFTER LIFTING THE VEHICLE, SUPPORT IMMEDIATELY WITH PROPERLY RATED AXLE STANDS.

USING THE AXLE STANDS



WARNING: BEFORE USE, MAKE SURE THAT THERE IS NO DAMAGE TO ANY PART OF THE AXLE STAND, IF THERE IS, DO NOT USE THE AXLE STAND.

WARNING: DO NOT EXCEED THE RATED LOAD OF 3 TON (PER PAIR).

WARNING: USE ONLY ON A HARD, FLAT SURFACE, E.G. CONCRETE.

1. Refer to the vehicle handbook for the correct jacking procedure and location of the support points.
2. Fully spread the three legs.

ADJUST THE AXLE STAND

1. Remove the locating pin (if fitted).
2. Raise the upper column to the required height and insert the locating pin into the lowest hole visible.
3. **Insert the retaining pin into the end of the locating pin** to secure it in position.
4. Position the axle stand under a suitable supporting point. See your vehicle manual for the location.

LOWERING THE VEHICLE

1. Slowly lower the vehicle onto the centre of the saddle

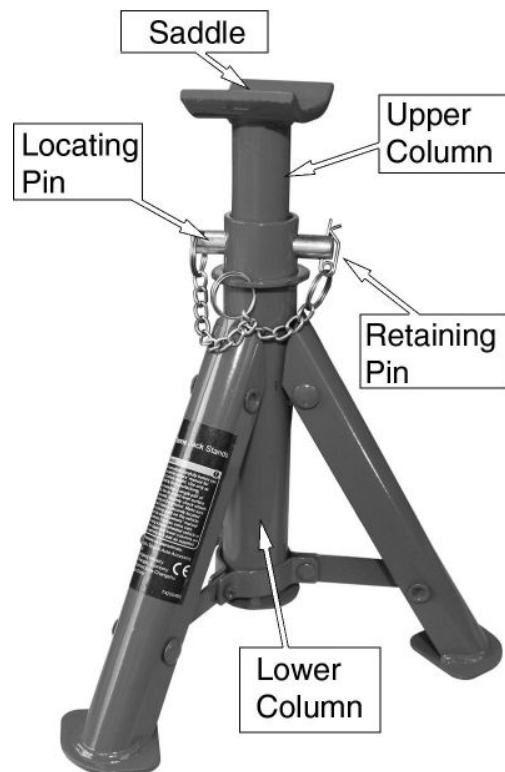

WARNING: DO NOT LOAD THE STANDS OFF CENTRE. FAILURE TO HEED THIS

WARNING MAY CAUSE DAMAGE, INJURY OR LOSS OF LIFE.

TO REMOVE THE AXLE STANDS

1. Raise vehicle clear of the axle stands.
2. Remove stands.
3. Ensure that all tools, equipment and personnel are clear before carefully lowering the vehicle to the ground.

SPECIFICATION

Capacity	3-Ton
Minimum Height	240mm
Maximum Height	360mm
N.W/G.W	4/4.3kg
Number of Height Positions	4