

**LALIZAS** 

*Life Saving*

**LALIZAS Pneumatic Line  
Throwing Device,  
SOLAS/MED/USCG,  
Set**

Codes: 75295

**MAINTENANCE & USER MANUAL**

# Contents

1. Safety Instructions – Warnings	3
2. General Description of the Product	3-4
3. Principle of Function of LALIZAS PLT	5
4. Instructions of Use	5-7
5. LALIZAS PLT Device Content	8
6. LALIZAS PLT Device Maintenance	8-10



# 1. Safety Instructions – Warnings



**CAUTION** : Every end user who is going to operate LALIZAS PLT Device, must be fully aware about its operation and have read and understood this manual before using.

1. This manual should be read before operating LALIZAS PLT Device to ensure correct maintenance and operation.
2. The licensee, manufacturer and distributor are not responsible for any damage or injury caused by LALIZAS PLT Device if not used according to this manual.
3. LALIZAS PLT Device must always be treated as high - pressure equipment and must not be pointed at people - animals or property.
4. LALIZAS PLT Device must not be used indoors or in confined space.
5. Before opening the compressed air cylinder valve (increasing unit's pressure), always have LALIZAS PLT Device in launching position with projectile placed on the device.
6. LALIZAS PLT Device must be held and stabilized well due to strong recoil force while launching.
7. Always check that the projectile, is filled with rope and the bottom end plug is mounted.
8. Always wear ear protection when operating LALIZAS PLT Device.
9. Keep away from children, intended only for emergency maritime use.
10. Do not dismantle & do not use if damaged or dented.
11. Keep away from heated sources.

EN

## 2. General Description of the Product

Pneumatic line throwing devices are commonly used for ship-to-ship or ship-to-shore line deployments, water rescues etc.

**LALIZAS Pneumatic Line Throwing Device consists of five main parts:**

1. Compressed air cylinder with valve



2. Cover of compressed air cylinder



3. Main mechanism (PLT body)

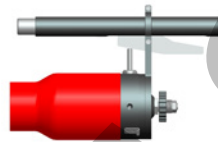

4. Launcher tube



5. Rope prefilled projectile (x4)



LALIZAS PLT Device set, is equipped with 4 rope prefilled projectiles and is capable of firing each projectile in a distance range of more than 230m complying with the requirements of Resolution MSC. 48(66) (LSA Code).

All the parts of LALIZAS PLT Device are reusable and the air cylinder is refillable from any 200 bar refill station for breathing air systems using the correct DIN200bar adapter. A full air cylinder (200bar filled) can supply 4 maximum range shots of LALIZAS PLT Device.

LALIZAS PLT Device is not a pyrotechnic technology unit, instead, the ejection of the projectile is based on the instant release of the compressed air from the air cylinder and for that reason it is safe to be used from and into flammable areas and also, it can be tested prior to use.

# 3. Principle of Function of LALIZAS PLT Device

- By turning CCW the air cylinder valve hand wheel, the compressed air flows from the air cylinder through the regulating valve into the main mechanism chamber.
- When the air of chamber reaches the desired pressure, the regulating valve stabilizes in closed position. At this point no air filling sound is apparent and the device is standby for launch.\*
- When the trigger is pulled, the trigger valve of main mechanism creates an instant vacuum, which pulls back the chamber piston, which releases the pressurized air in order to flow directly through the launcher tube at the bottom of the projectile cap causing the ejection.
- While ejection, the unit creates a huge recoil force, so it must be stabilized very well.

\* There are overpressure safety valves both to the main chamber and the air cylinder valve, in order to protect the device and the operator from accidental overcharge.

# 4. Instructions of Use

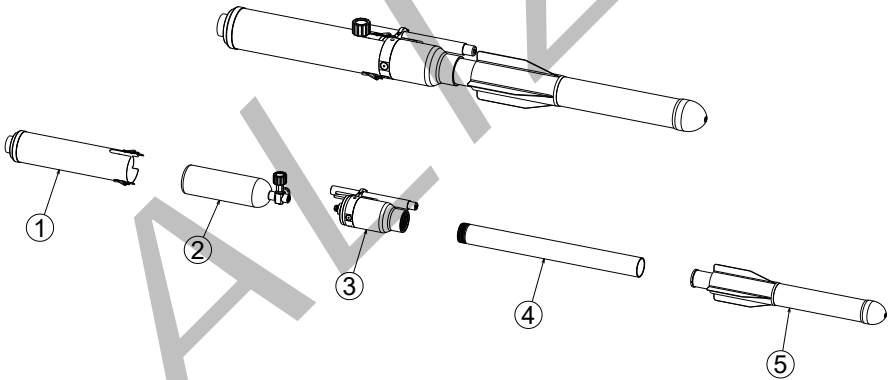

A/A	COMPONENT
1	CYLINDER CASE
2	CYLINDER WITH VALVE
3	MAIN MECHANISM
4	LAUNCHER TUBE
5	PROJECTILE

Figure 1: Reference Assembly Figure of LALIZAS PLT Divece

**1**

Screw the air cylinder to the main mechanism (see Reference Assembly Figure Component 2 to 3) and mount above the cylinder case (Component 1). Make sure that the air pressure is sufficient for shooting (>120bar).

**Illustrated Instructions**

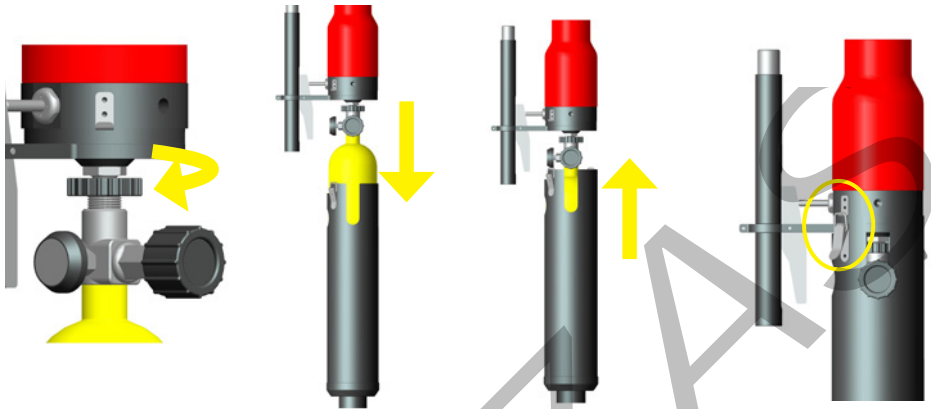

**2**

Make sure the launcher tube is clean without any dirt inside and screw onto the main mechanism shell (see Reference Assembly Figure Component 4 to 3).

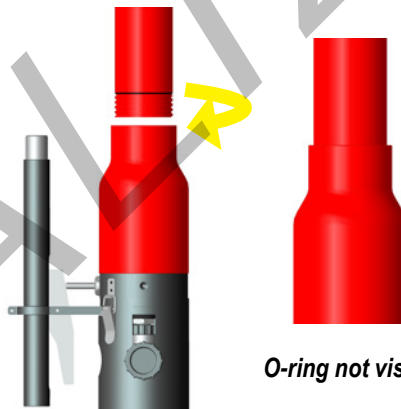

**3**

All the projectiles are prefilled with rope. Pull a sufficient amount of rope so that you can fasten it to a steady fixed spot or to the following connecting line. Guide the rope through the slot on the white cap and slide the projectile onto the launcher tube, as far down as possible and make sure that it slides really easily. (see Reference Assembly Figure Component 5 to 4).

6

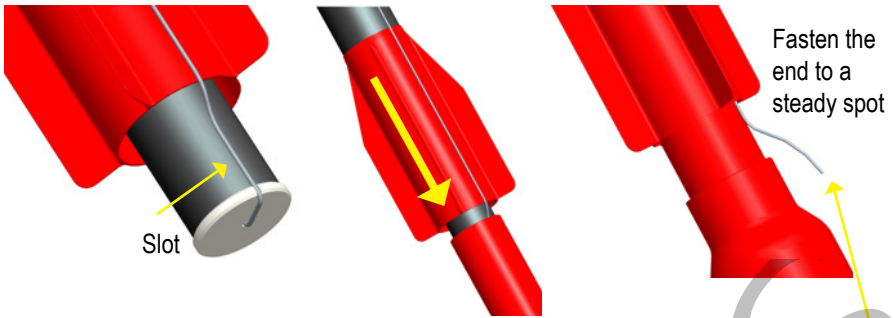

4

Fill the main mechanism chamber with compressed air by opening the valve on the air cylinder. You will hear the air flow through the regulating valve into the chamber. Shut the cylinder valve after 8 - 10 seconds or when you hear the airflow has stopped. (see Reference Assembly Figure Component 3).

**CAUTION:** Do not use excessive force when closing the handle wheel as this may damage the valve seat.

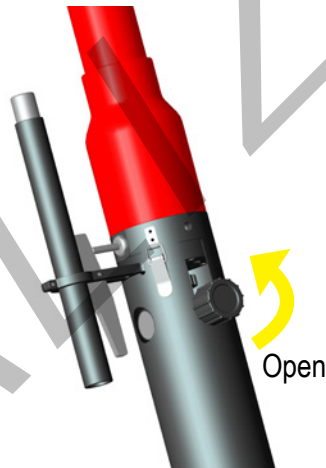

5

Stabilize well LALIZAS PLT Device in approximately 35° shooting position to reach the optimal range. Make sure the unit is well supported against a solid surface.

6

Observe and aim your target. Press and hold with your thumb the trigger safety button (on top) and pull the trigger.

7

## 5. LALIZAS PLT Device Content

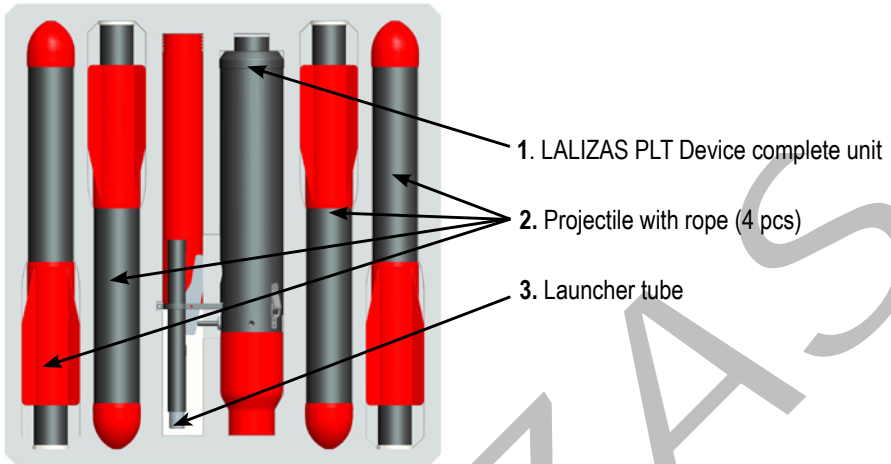

## 6. LALIZAS PLT Device Maintenance

After each use:

- MAIN MECHANISM

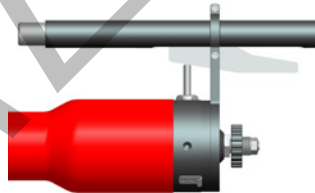

Wipe the PLT with a towel rinsed in fresh water, to remove any salt layers for the sea environment. Dry it with a clean towel to prevent oxidation.

Use a type of lubricant (silicone or water displacement oil) and apply a few drops to the inlet (cylinder valve side) and the exhaust trigger to prevent corrosion build-up inside the mechanism while stored. Wipe off the excess.

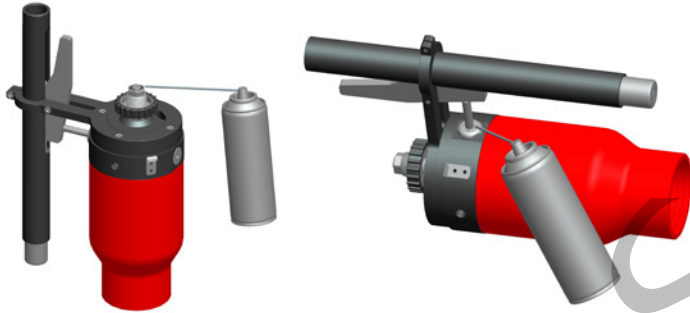

- **AIR CYLINDER**

Use a G5/8 adapter from the charging station in order to refill the air cylinder **ONLY** with clean and dry air. Set the filling pressure to 205/210bars.

Follow the cold bath method when refilling the air cylinder, as if the temperature rises when refilling the indicated value will be reduced when the cylinder is cooled down.

In any case, after cool down check again for the correct pressure and repeat the filling step if needed.

*\*Do not use excessive force when closing the handle wheel as this may damage the valve seat.*

- **LAUNCHER TUBE**

Inspect the launcher tube internally for damages or dents and clean it with a fabric or cloth wrapped pole by doing up-down motions.

- **STORE LALIZAS PLT DEVICE IN SAFE AND DRY PLACE**

**Monthly check:**

Remove the unit from the storage bag and proceed with a visual inspection test. Check the air cylinder pressure gauge and confirm there is no pressure loss. Check the whole product for imperfections or damages and store the unit again in safe and dry place. Never store LALIZAS PLT Device with pressure in chamber (standby for firing position).

**Annual check:**

Remove the product from the storage bag and check for correct movement of the trigger assembly. Open the air cylinder hand wheel and fill the PLT one time. Screw the launcher tube (to reduce the noise of free firing w/out projectile). Check the main mechanism for air leaks.

*\*If air leaks or any other unusual behaviour of the device is detected, please contact the nearest LALIZAS authorized service station or LALIZAS S.A.*

Aim away from people – animals or property, and launch the LALIZAS PLT Device. Confirm the correct function and refill the air cylinder up to specs. Store LALIZAS PLT Device in safe and dry place.

**Other:**

LALIZAS PLT Device should be maintained after 5 years to achieve factory condition.

LALIZAS PLT Device air cylinder should be periodically tested, according to the National Regulations, Laws and Standards regarding the use of such equipment in the country of use. If all the above are not applicable the hydraulic test should be conducted every five (5) years after the manufacturing date of the air cylinder.

**To guarantee safe operation of LALIZAS PLT Device, only genuine spare parts should be used as per below codes:**

**75454 - Projectile Assembly for LALIZAS PLT**



**75455 - Air Cylinder Assembly for LALIZAS PLT**



LALIZAS

LALIZAS

**LALIZAS** 