

ALKALINE-MANGANESE DIOXIDE BATTERY

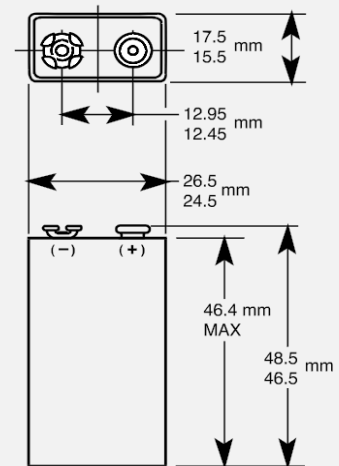

Size: 9V (6LR61) PX1604



Dimensions shown are IEC standards

KEY FEATURES

- Reliable Performance
- Excellent resistance to corrosion
- Designed to meet all major quality, safety and environmental standards:
 - Safety: IEC 60086-5
 - ANSI C 18.1M, Part-2
 - EU Battery Directive
 - Quality: ISO 14001 and 9001, Duracell World Class Continuous Improvement Program

TYPICAL APPLICATIONS

- Carbon Monoxide Detectors
- Smoke Detectors
- Multimeters
- Medical Devices
- Microphones

ELECTRICAL CHARACTERISTICS

- | | |
|---|----------|
| ▪ Nominal capacity (2 mA Cont., 5V cut-off) | 628 mAh |
| ▪ Typical Voltage (at + 20 °C) | 9 V |
| ▪ AC Impedance @ 1kHz | 1,692 mΩ |

PHYSICAL CHARACTERISTICS

- | | |
|------------------|---|
| ▪ Typical weight | 45.3 g (1.6 oz) |
| ▪ Typical volume | 22.8 cm ³ (1.4 in ³) |
| ▪ Terminals | Miniature snap |

OPERATING & STORAGE CONDITIONS

- | | |
|--|----------------------------------|
| ▪ Operating temperature range | -20°C to 54°C
(-4°F to 130°F) |
| ▪ Recommended Storage (storage area should be clean, cool, dry and ventilated) | 5°C to 30°C
(41°F to 86°F) |

Delivered capacity is dependent on the applied load, operating temperature and cut-off voltage. Please refer to the charts and discharge data shown for examples of the energy/service life that the battery will provide for various load conditions.

to change. Performance information is typical. the latest information.

TYPICAL PERFORMANCE

Constant Current

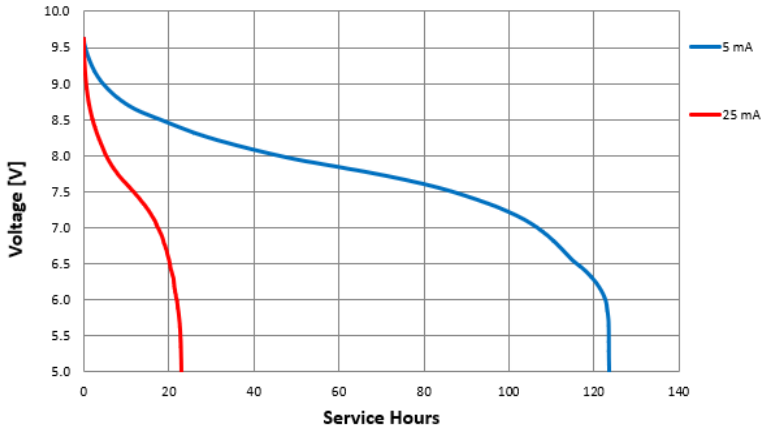

Constant Current

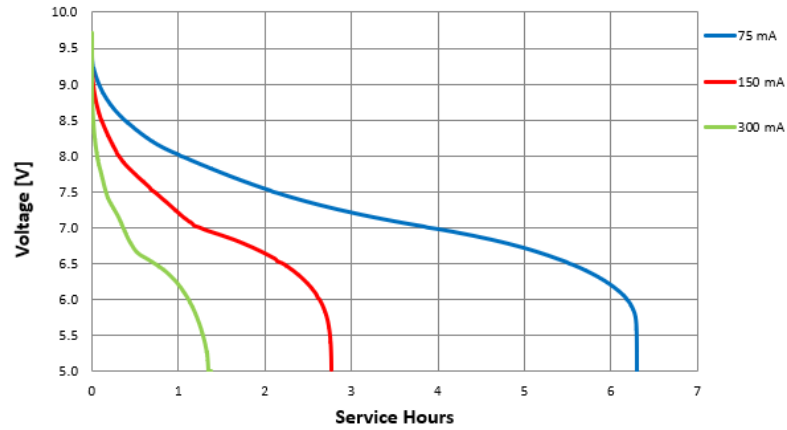

Constant Resistance

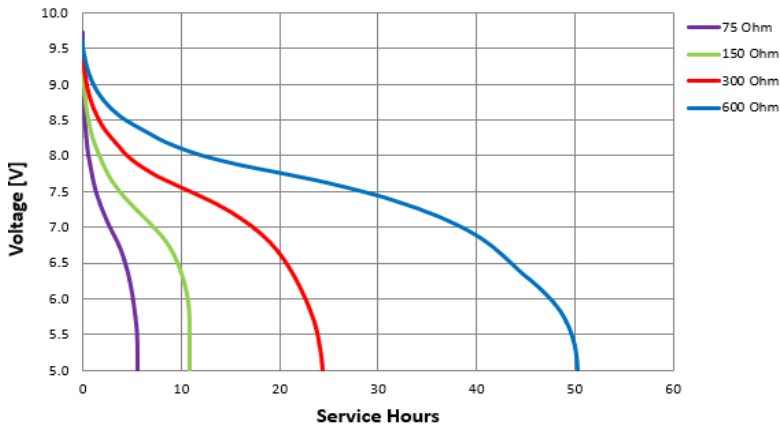

Constant Power

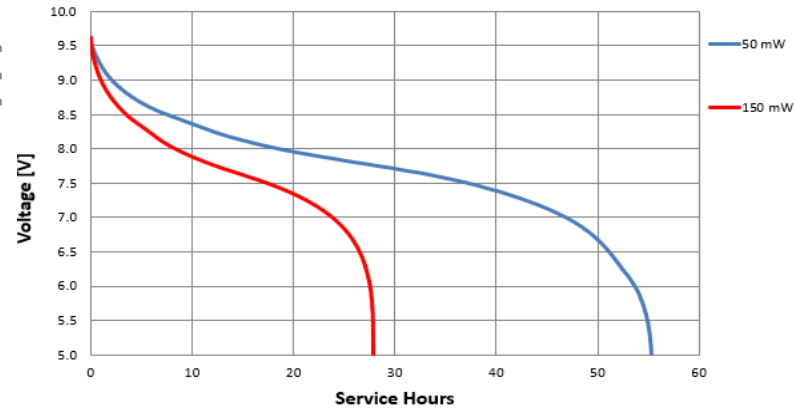

Constant Power

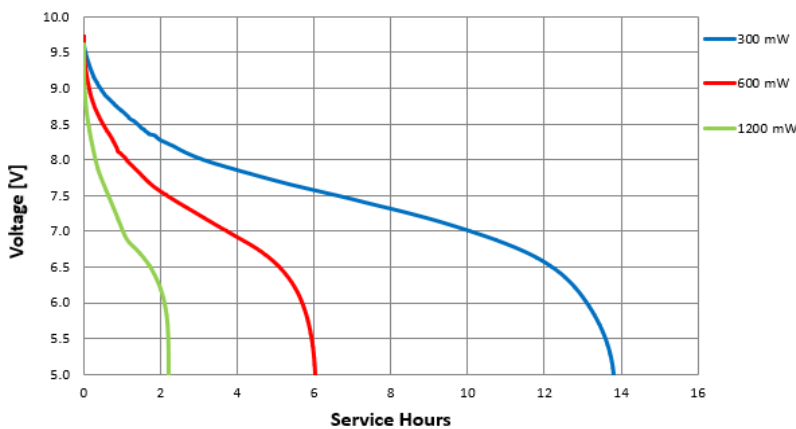

Constant Temperature - 75 mA

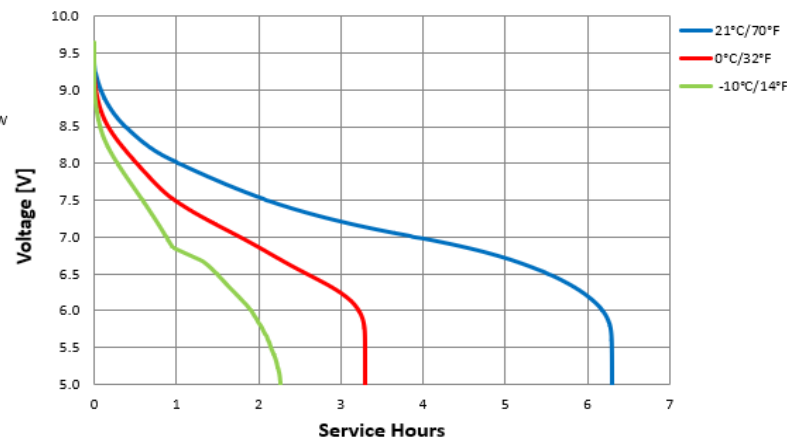

Delivered capacity is dependent on the applied load, operating temperature and cut-off voltage. Please refer to the charts and discharge data shown for examples of the energy/service life that the battery will provide for various load conditions.

This data is subject to change. Performance information is typical. Contact Duracell for the latest information.